

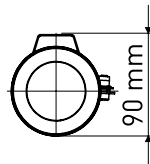

Sammode
Studio

Dix

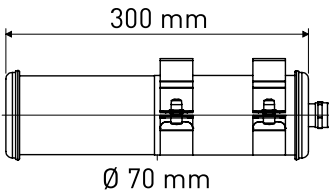
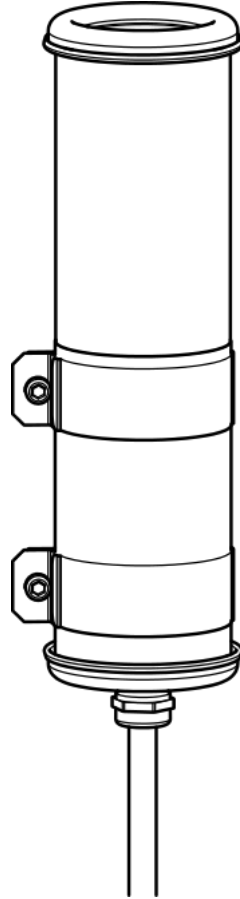

Montage

Mounting / Montage

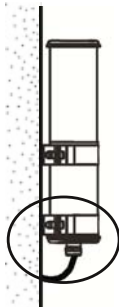
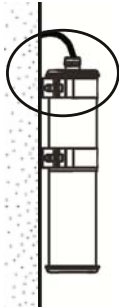
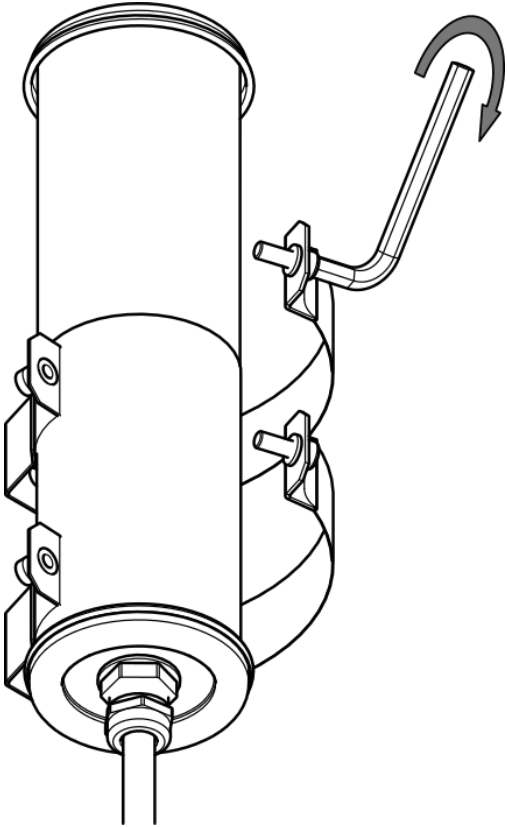

Changement de lampe

Change the lamp / Lampenwechsel



Les lampes fournies par Sammode permettent un fonctionnement optimal du produit.
En cas de remplacement, nous recommandons l'utilisation de modèles strictement équivalents.

Lamps are provided by Sammode for an optimal functioning.
In case of relamping, we highly recommend the use of similar lamps.

Der besten Betrieb der Leuchten wird mit von Sammode gelieferten Leuchtmittel geprüft.
Beim Austausch der Leuchtmittel empfehlen wir ähnliche Leuchtmittel zu verwenden.

1.

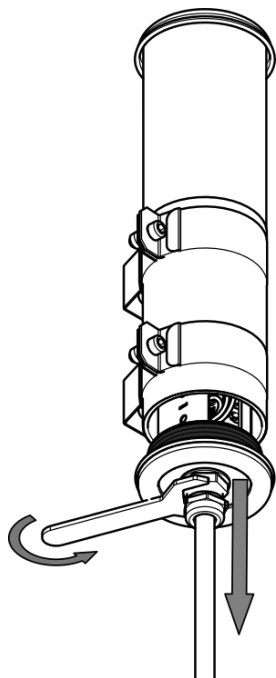

2.

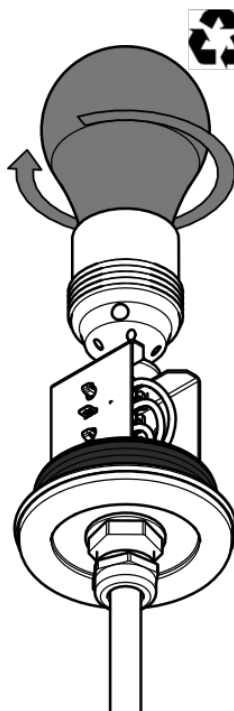

3.

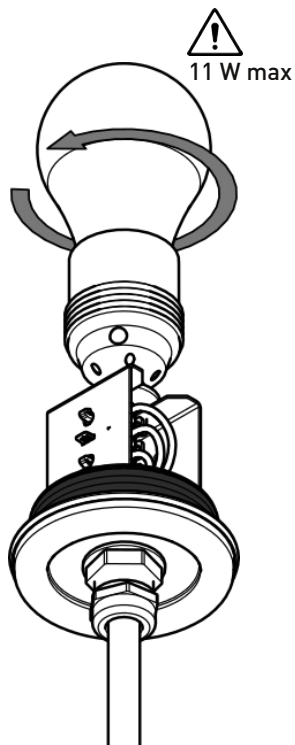

Ne pas ouvrir sous tension
Do not open when energized
Nicht unter Spannung öffnen

4.

